

# Servo Proportional valve

## HVM 065

Primarily Version

Single stage electro hydraulic Proportional valve with position feedback  
Mounting style NG 6/ Cetop 03

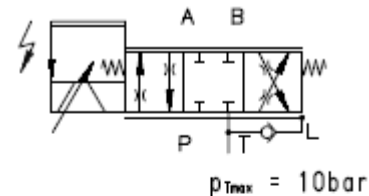
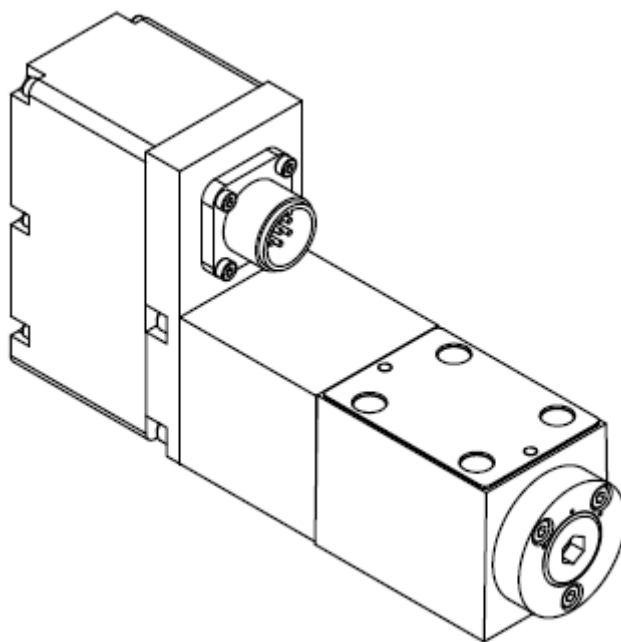

### Description

Single stage proportional valve in longitudinal piston slide building method (directly actuated) with linear motor.

The position feedback of the pilot piston is realized over a LVDT displacement gauge and digital on board electronics. By the high strength reserve of the linear motor, the valve can be operated also in hydraulic fluids of smaller categories of purity with a good resolution. Further the proportional valve HVM 065 possesses outstanding dynamic and static characteristic values.

### Special characteristics

- \* Robust and compact design
- \* Position closed loop adjustable with USB interface
- \* High power reserve of the Linear motor
- \* Reduced dirty oil sensitive
- \* Flow  $Q_{max} = 40 \text{ l/min}$  with  $\Delta p = 35 \text{ bar/edge}$
- \* Pressure  $p_{max} = 315 \text{ bar}$
- \* Hydraulic and electric zero adjustment
- \* Emergency movement without electrical power possible

## Cutting view HVM 065

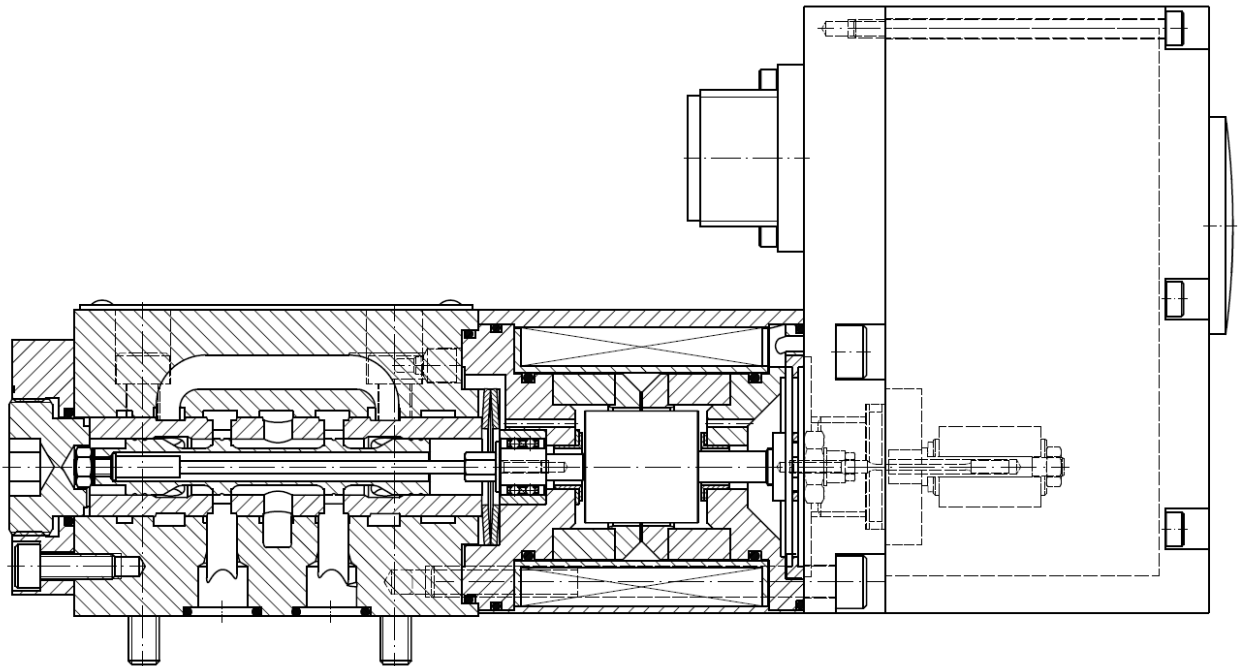

## Technical data

A Hydraulic data			B Electrical data	
1. Operating pressure	$p_b$	210 bar	Electrical connection 6 Pin + PE DIN 43563	
2. max pressure	$p_{max}$	315 bar	1. Power supply	24V DC (20...28V)
3. Return pressure max.	$p_{Rmax}$	10 bar	2. Signal input	
4. Leakage oil pressure		L internal with T conn.	a. voltage	0...±10V
5. Rated flow at $\Delta p$ 70 bar	$Q_N$	10/20/40 l/min	b. current	4 up to 20 mA
6. Zero flow	$Q_{01+02}$	< 4 %	3. Signal direction	from Pin D to Pin E
7. Hysteresis	H	< 0,1 %	4. Flow direction	+10V = P to A and B to T
8. Threshold sensivity	E	< 0,1 %	5. Protection level	IP 65
9. Threshold span	S	< 0,1 %	6. EMV	EN 61000-6-2 EN 61000-6-4
10. Linearity deviation	L	< ±5 % $Q_N$	7. Service connection	USB Type B
11. Pressure gain	$V_p$	> 0,2 $p_B/1\%Soll$		
12. Overlap standard	h	-1 to +3 %		
13. Step response time	t	< 8 ms		
14. Operating temperature range	$\vartheta$	253 to 353 K		
15. Temperature drift		< 1 % / 50 K		
16. Viscosity range of fluid		10 to 1000 mm <sup>2</sup> /s		
17. Fluid standard		ISO VG 10 to 68		
18. Filtration (recommended)		ISO4406Klasse16/14/11		

## Diagram

### Static flow diagram

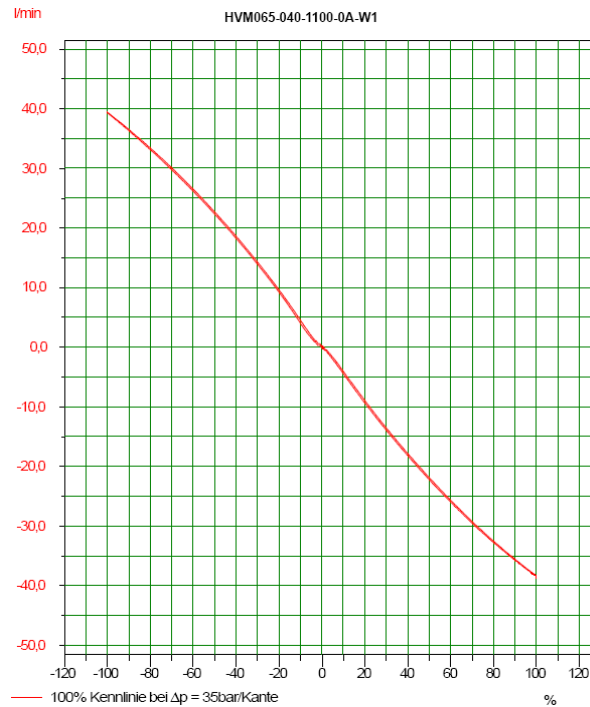

### Pressure gain



## Dimensions

A	24 VDC
B	0 V
C	Signal 0
D	± 10 V
E	0 V
F	
G	PE

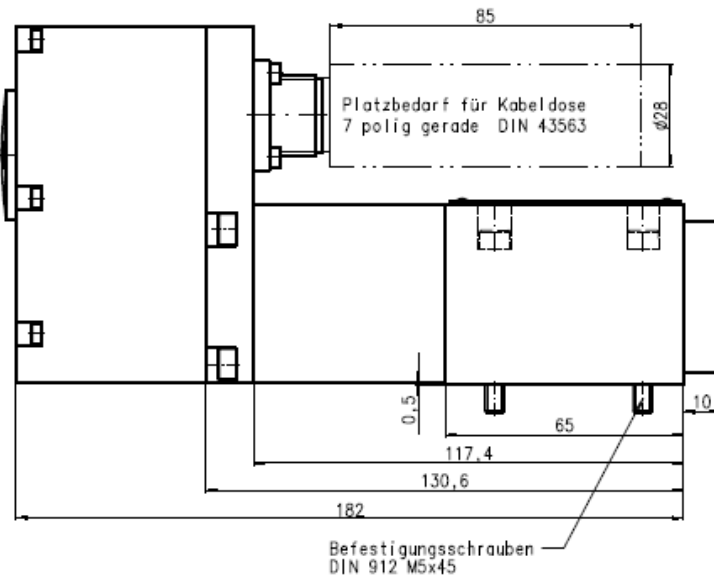
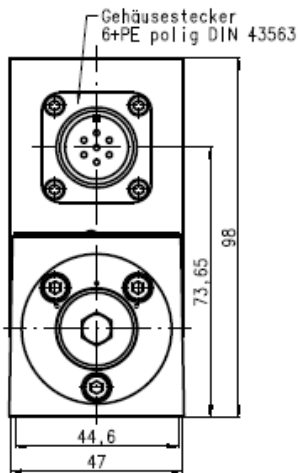
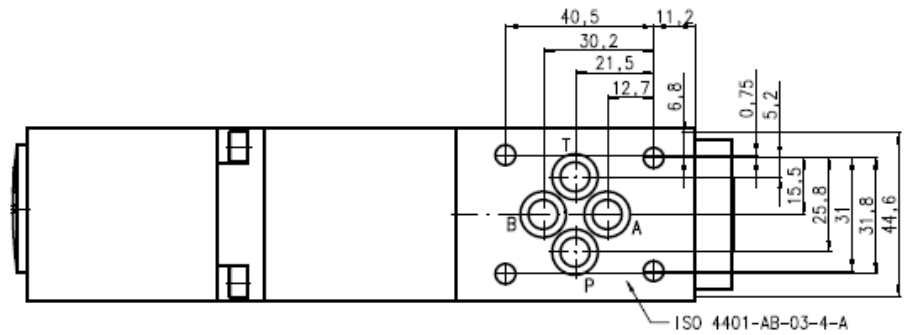

**Order code**

HVM

Hydraulic  
Valve  
flow

Type

065 Valve  
with feedback

Rated flow

40 l/min with  $\Delta p$  35bar

Sealing/ coils/lapping

1	2	0	0
1 Perbunan	1 4,5 $\Omega$ coil	0 zero lapping	0 zero
2 Viton		1 overlapping	1 size
3 Butyl		2 under lapping	
4 Vulkollan			
5 Ethylene Pr.			

Construction level

Factory definition

Elektronic with LVDT

W1 voltage input  $\pm 10V$

W2 current input 4 to 20 am

065

040

1100

0A

W1